

HM-CATBOX
**INSTRUCTIONS
OF SMART
CAT LITTER BOX**

Directory

1	Product Function Introduction	02
2	Instructions (Required)	05
3	Quick start	06
4	Operation Introduction	07
4.1	Connection APP	07
4.2	Add cat litter	12
4.3	Mode of operation	13
4.3.1	automatic mode	13
4.3.2	sleep patterns	14
4.3.3	manual mode	14
4.4	Clearance function	15
4.5	Protection mechanisms	16
4.6	Skills	16
4.7	Spare parts removal	17
5	Troubleshooting	19

1 Product Function Introduction

This is a fully automatic smart litter box that automatically cleans up the cat's litter. It automatically cleans up the cat's litter after it has finished using the toilet.

You can download the Home and Pet App, connect the device and set the device to fully automatic, manual and night time modes. You can also check the remaining litter level, the status of the device, the current mode and the device notifications. If you do not want to connect to the app, the device will run in full automatic mode by default.

The device has multiple safety guarantees during operation, such as anti-pinch-ing and automatic stop when the cat enters during operation. Automatic stop and protection in the event of an abnormality to ensure no harm is caused to you or your pet.

Specifications		
Main parameters	adapter power	220VAC-50Hz-0.1A
	Machine power	12VDC-1A
	Rated power consumption	10W
	WiFi support	2.4G/5G Network
	Working altitude	Below 117900 Inches
	Working humidity	10% - 90%
	Function	Ozone Sterilisation Automatic Sifting Clearance
	Machine size (length, width and height)	22x22x26 Inches
	Total weight	24.25 Pounds

| The size of the machine is as follows

Machine height 26 Inches, width/diameter 22 Inches.

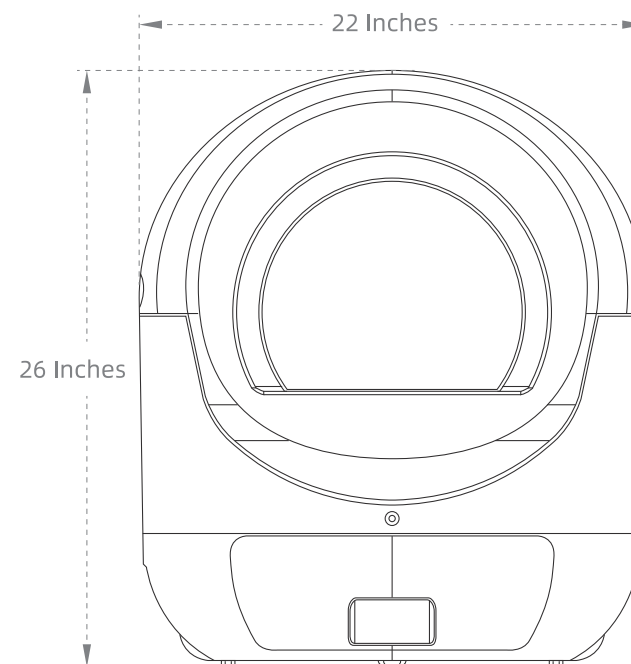

| Packing list

- HM-CATBOX smart cat litter ×1
- Description ×1
- Power adapter ×1
- Cleaning brush ×1

I Components

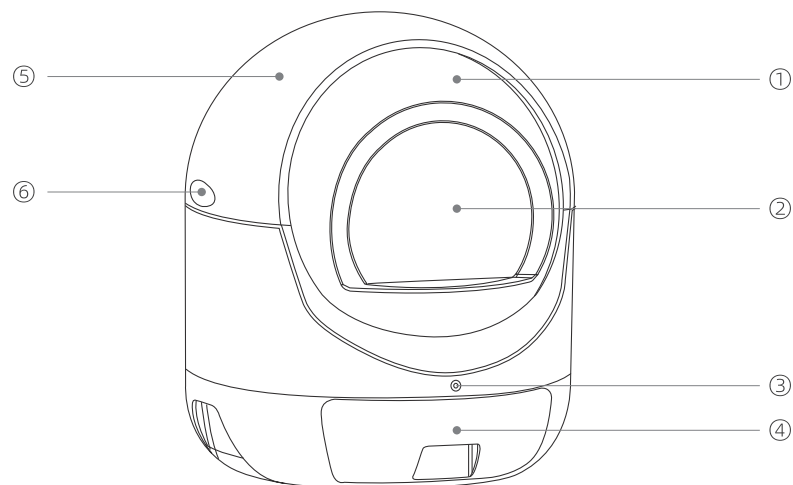

- ① Removable roller
- ② Removable curtain (optional)
- ③ Button
- ④ Storage drawer
- ⑤ Removable cover
- ⑥ Top cover bayonet
- ⑦ Power socket

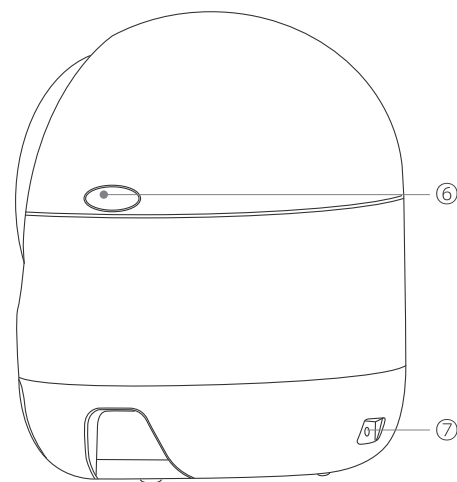

2 Instructions (Required)

Please strictly abide by the following regulations during use to ensure the normal operation of the machine. It is also to ensure the safety of you and pet.



- The HM-CATBOX Smart Litter Box is only suitable for cats weighing **2.2 Pounds** and above, and it is also recommended that cats weigh up to **33 Pounds**.
- Please use the original power adapter, otherwise there is a risk of damage to the unit and fire.
- Please place the machine on a dry, flat and sturdy surface for operation. Do not place on soft surfaces such as carpets, yoga mats, etc. as this may prevent the machine from working properly.
- Do not dismantle or tip the machine while it is in operation.
- Disconnect the machine from the power supply before dismantling any removable parts.
- Do not stack any objects on the machine as this may affect the normal operation of the machine.
- Do not put your hands into the drum mechanism while the machine is in operation.
- Do not switch between cleaning and emptying tasks at will, you must wait until the current task is completed.

3 Quick Start

You can quickly connect and use HM-CATBOX smart cat litter basin according to the tips on this page.

(If you don't want to connect to the network, the device is in full automatic mode by default.)

Before starting, ensure the installation of the equipment is complete. Place the equipment on a solid plane to make the equipment in good contact with the ground, and there are no other sundries on the shell of the equipment.

First of all, You need to download an APP. You can search for "HMPet" through the app store in your phone, or scan the right QR code to download the installation.

After installation, open the APP, registration account and login, click on the home page to add equipment, according to the instructions to complete the binding operation.

After the equipment binding is completed, pour the cat litter (maximum 6 L) into the equipment drum bin and re-power (unplug the power for 15 seconds and re-power).

After completing the above operation, you can enter the device control page by APP the bound device in the home page.

At this point, you can start using smart cat litter in automatic mode.

If you can't complete the configuration or want to know more, please refer to the details below.

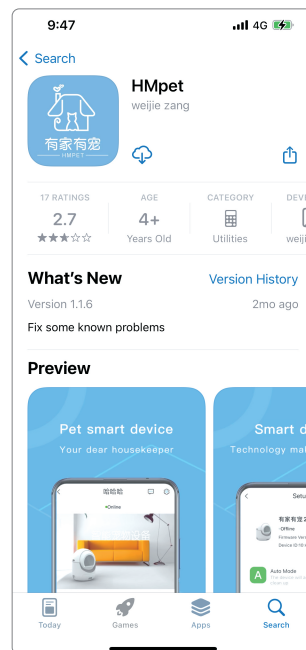

4 Operation Introduction

4.1 Connection APP

To use all the functions of the cat litter basin, you first need to configure the network for the equipment. Smart cat litter can be connected to the network through WiFi, and remote control and viewing devices APP mobile phones.

Scan the right QR code or search for "HMPet" APP, through the phone's built-in app store for download. After the download is complete, you can start to prepare the distribution network work.



- First, place the equipment smoothly on a flat and solid ground, and ensure that the four support feet (including sensors) at the bottom of the equipment are in effective contact with the ground.
- Can not be placed on the carpet, yoga mat and other soft plane, otherwise the equipment may not work properly.
- Before starting operation, make sure the equipment is out of power, and the top cover and drawer of the machine are installed on the machine completely, and there is no sundries inside the machine.
- Follow the following steps after preparation.

Open "HMPet" registration account and login completed. Go to Home, Click "+" to add pet equipment, and select Smart Cat Sand Pot device in the device list.

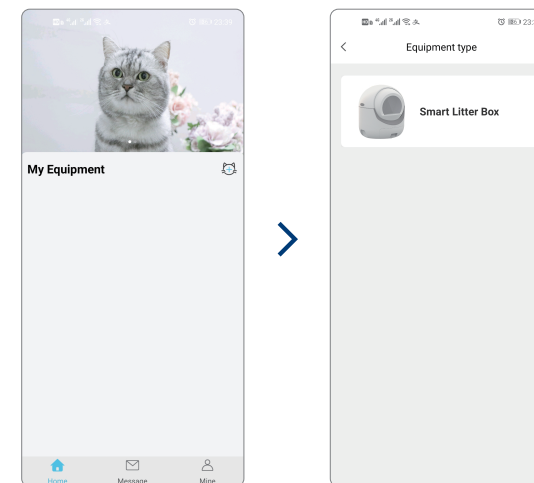

Then go to the binding device page. According to the APP page prompt, **press and hold down the button in front of the device, then plug in the power supply**. After hearing the device "drop" twice, loosen the button. Check the small circle at the bottom of the APP page for the next step.

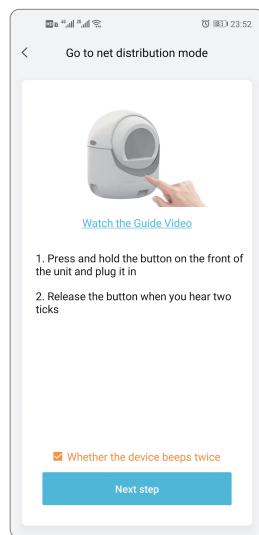

Step 3, Enter to the WIFI of the device to work .

(1) Click on **change Network** to switch the current WIFI to the 2.4G/5G (**5G brand WIFI will include the word "_5G after the general name)** band commonly used in your home, or simply click on the WIFI name field and input the WIFI name directly.

WIFI name of home ►
Home WiFi password ►
(password must be correct)

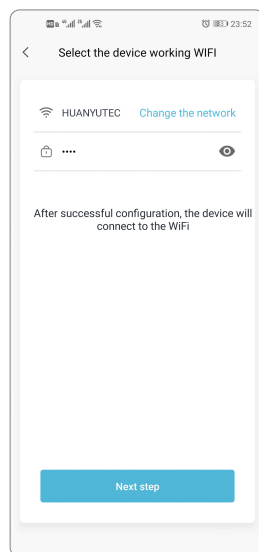

Click next ►

(2) Manually enter the wifi password , the password must be correct, otherwise the device will always be offline.

(3) Click Next.

Step 4, in the current page. You need to switch the WiFi connected to your mobile phone to WiFi that the device sends out with the name 'yjyc_digit'. You can click (click to set up the network) or enter the mobile phone wifi settings page to switch the network to the wifi starting with yjyc_.

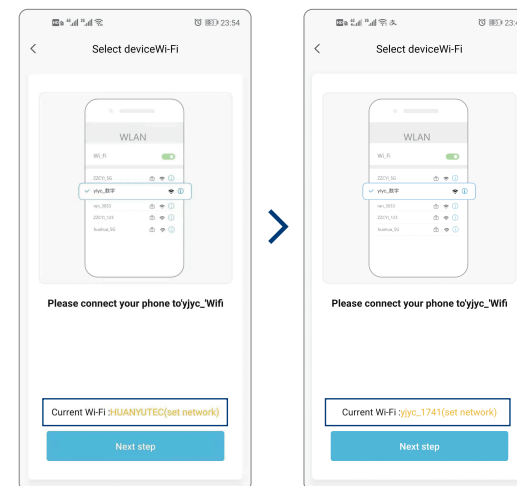

Notes:

If there is no "yjyc_" wifi in the wifi list, you need to unplug the device and wait for 10 seconds, then press and hold the button on the front of the device with one hand, power it on with the other hand, and then release the button when you hear the drip. the device will send out wifi starting with yjyc.

Enter the binding device page

(1) Give the device a name

(2) Click OK, you can see that there is a device with the input name on the home page that is successfully bound.

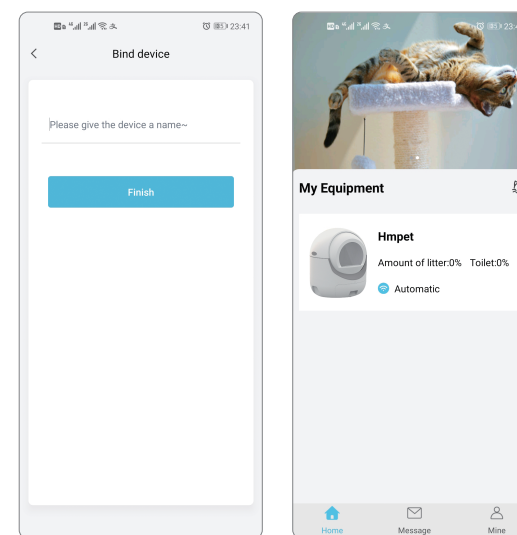

Enter the device control page

The 4 display areas respectively indicate:

Cat litter volume: remaining proportion of equipment cat litter.

Bin Bin: the space already used by Bin Bin.

Mode: Indicates the current working mode of the device, there are three modes: automatic, manual, and night.

Status: Indicates the current working status of the device, standby, cleaning, cleaning pause, resetting, Reset pause, clearing, and clearing pause several states.

The functions of the buttons are as following:

Reset: When the drum is not in the initial position, you can click Reset to reset the drum. After adding the cat litter, you can also click the reset button to reset the device to prevent it can not automatic cleaning in some time **(before clicking the reset button and within the next 5 seconds, make sure that There is no cat around the device, otherwise the cat may be harmed).**

Clean up: Click on clean up to separate the feces and cat litter in the drum.

Clearance: Click Clearance to clear all the feces and cat litter in the drum to the drawer, which is generally used when replacing the cat litter.

Deodorization : after clicking deodorization, the ozone sterilization and deodorization function of the device will be started, and the device will automatically shut down after working for about 1 minute.

Click the message icon in the upper right corner to enter the notification and log messages pushed by the device.

Click the settings icon to enter the settings page of the device.

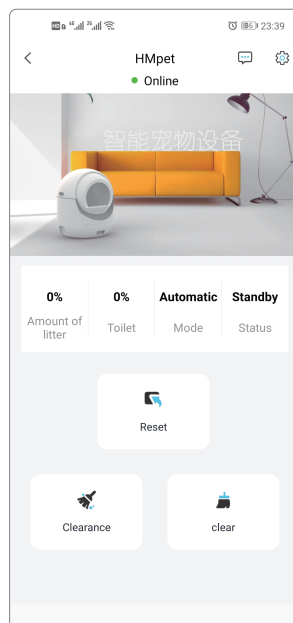

Notes: If the device is offline, the third step during binding does not match the home wifi and password.

Enter the device settings page

The device setting page is used to set the device name, working mode, cat litter weight, notification settings, and device sharing.

(1) Click the edit button to modify the device name

(2) Automatic mode switch: Turn on the automatic mode device and it will automatically clean up after the cat goes to the toilet

(3) Waiting time: How long is the delay for cleaning after the cat goes to the toilet? The minimum time is 0. The device will start cleaning after the cat has left for 30 seconds.

(4) Sleep time: When the sleep time is turned on, the device will not automatically clean up from the set start time to the end time, and it will automatically clean up during the rest of the time

(5) Cat litter weight: It is used to calculate the remaining amount of cat litter, the value filled here is the weight of 6L (liter) of cat litter you use, for example:if you input 4kg, it means that the machine can hold 4kg of cat litter at most. If it is suggested by the the control the page that the remaining amount of cat litter is 50%, the remaining cat litter in the drum will be 2kg.

(6) Notification settings: After turning off the notification device button, the app cannot accept messages pushed by the device

(7) Device sharing: Click "+" and enter another account (phone number) registered with the Jiayoubao app to share the device with each other. This is for the purpose of multiple people managing the device together.

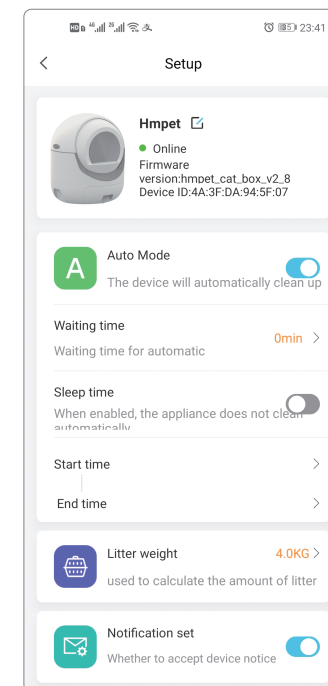

4.2 Add cat litter

Cat litter type supported by equipment
Bean curd sand compatibility
support strip pure bean curd sand, mixed bean curd sand, and all granular sand such as bentonite, millet sand, etc.
<p>✘ We recommend the use of "Monicoli" or "A pet" mixed cat litter and sodium-based litter. The hybrid cat litter has strong deodorizing and agglomeration characteristics and is specially developed for HM-CATBOX smart litter box.</p>

- You can add cat litter to the cat litter basin at any other time except when the equipment is running and cleaning. Pour the cat litter directly from the drum door.
- HM-CATBOX the maximum allowable cat litter capacity of the smart cat litter basin is 6 L(liters), exceeding that capacity will affect the use effect.
- After each litter addition, please restart the power for 15 seconds, plug in or click the reset button on the app control page.
- If you do not restart the device after adding the litter or click the reset button, the litter data will be updated after a period of time. Meanwhile, the automatic cleanup function does not run until the litter volume is updated.

4.3 Mode of operation

HM-CATBOX smart cat litter box currently has three operating modes. They are automatic mode, manual mode and night mode. Set through the automatic mode switch and sleep time on the APP device setting page.

(Turn off the automatic mode and sleep time at the same time, the device will be manual mode. If turn on the automatic mode and turn of sleep time , the device will be set to night mode. Before you turn on the sleeping time, you must turn on the automatic mode)

No matter what mode the device is in, or under any circumstances, you can use the button on the front of the device and the "Clean up" button in the APP device control page to manually clean up.

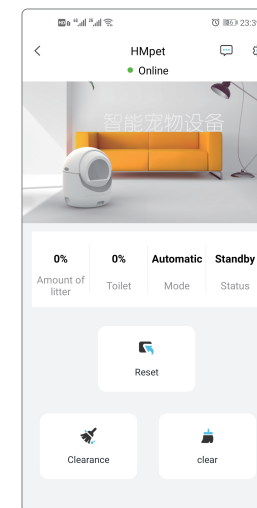

4.3.1 automatic mode

- The smart litter basin is in automatic mode by default (even if no network is configured).
- When the device is in automatic mode, the device has all-weather automatic cleaning and automatic identification protection functions.
- When the device detects that the cat has finished going to the toilet, the device will automatically clean up after waiting for the delay time set on the setting page. It is recommended to set the delay time to about 6 minutes to make the feces and cat litter fully clump together.
- In automatic mode, you can also press the front button of the device for 3~5 seconds or manually through the cleanup button in app.
- In automatic mode, you can also press the front button of the device for 3~5 seconds or manually through the cleanup button in app.
- When the cat litter is too less, the storage compartment drawer space is insufficient, or the device is abnormal, the device will send you reminders and notifications through the APP

4.3.2 sleep patterns

- You can switch to sleep mode and sleep time periods through the app mode switch button. No longer automatically detect and clean up when the device is in sleep mode.
- When the device is in sleep mode, the device will no longer automatically detect and clean up during the set sleep start and end time periods. However, you can still manually clean up by pressing and holding the device button for 3~5 seconds or by clearing button in the APP.
- In sleep mode, the device remains in automatic mode except for the sleep period. Contains all the functionality of the automatic mode.

4.3.3 manual mode

- You can switch to manual mode by APP.
- In manual mode, the device is no longer automatically detected and cleaned. You can only manually clean by pressing the device button for 3~5 seconds and through the cleaning button in the APP.
- Manual mode is suitable for users who want to clean up according to their own needs and manually operate on the spot.

4.4 Clearance function

HM-CATBOX intelligent cat litter basin has clearance function. Easy for you to simply and quickly replace cat sand.

When you feel that the cat litter in the drum bin needs to be cleaned and replaced at one time, you can use the clearance function to clean all the cat litter in the bin into the storage drawer below. Then add the cat litter again.

You can press and hold the button for more than 7 seconds and release it after hearing the device emit a didi, or use the clearing button in the mobile APP to perform the clearing operation.

- Please make sure there is enough space in the storage drawer below before clearance.
- Do not unplug the power during clearance.
- Do not interrupt the operation at will during the clearance process.
- Please observe the whole process during clearance.
- You can stop the task by clicking the device button when the drum leak is at the bottom during clearance. Then use the official small brush to further clean up the dust. After cleaning, press the button or continue the clearance task through APP control.

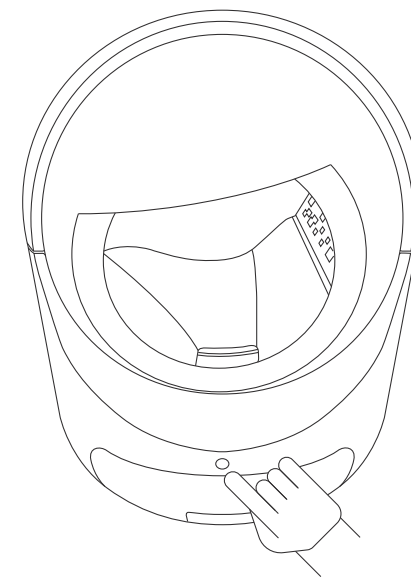

4.5 Protection mechanisms

HM-CATBOX intelligent cat litter basin has automatic protection function. But the protection function is different in different modes. See the table below for details:

Mode of operation Cleaning Trigger Mode	Cleaning Trigger Mode	Cleaning kittens in Automatic stop	Anti-clam
Automatic	Automatic detection	Support	Support
	Manual cleaning	Support	Support
Sleep patterns	Automatic detection	Support	Support
	Manual cleaning	Support	Support
Manual mode	Manual cleaning	support	Support
Clearance	Manual clearance	No support	Support

4.6 Skills

The following will show you some tips in the operation of the device for your quick use.

- At any time, you can press the device button for 3~5 seconds to clean up.
- At any time, you can press the device button for 6~10 seconds to perform the clearance task.
- During cleaning or clearing, you can pause by pressing the device button. After pause, you can manually trigger the task again, and the device will continue to run. If no operation is carried out, the device will automatically return to normal position after a period of time.

- During cleaning or clearance, if the cat enters the cat litter basin, the device automatically stops running. After a period of time to return to normal, the device will continue the current task or return to its initial position.
- During the cleaning of the cat litter basin in automatic mode, if you find an exception, you can press the button or press the device shell to suspend the operation of the device. After returning to normal, the device will continue the current task or return to its initial position.

4.7 Spare parts removal

HM-CATBOX the drum bin of the intelligent cat litter basin and the drawer bin below the storage bin can be removed and cleaned.

Before removing the accessories, please cut off the equipment and clean up the debris in the parts to be cleaned. After cleaning, please dry the equipment and install it back into the equipment.

Storage drawer cleaning:

Remove and clean the drawer. After cleaning, be sure to dry and put it back into the machine.

Please use clean water cleaning, can use ordinary household detergents, disinfectant, do not allow the use of strong corrosive detergents.

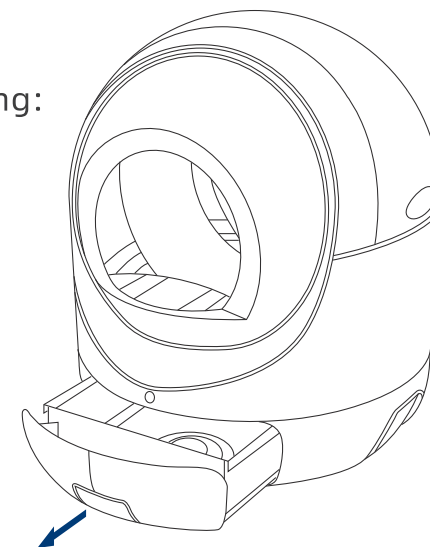

Drum cleaning:

The first step is to press the upper cover buckle on both sides of the equipment and remove the upper cover.

In the second step, lift the drum forward slightly and remove it without screws.

Remove the drum bin and clean it. Please use clean water cleaning, can use ordinary household detergents, disinfectant, do not allow the use of strong corrosive detergents.

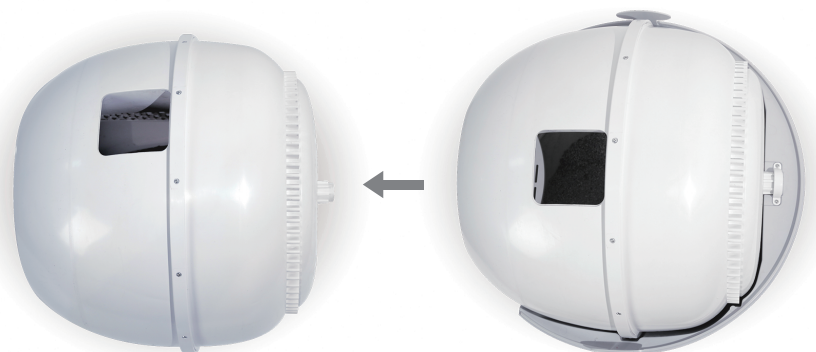

- After the cleaning is completed. Please dry all accessories and dry the remaining moisture and install them on the machine.
- Before running the equipment, please ensure that all accessories are fully installed on the equipment, otherwise it will affect the function of the equipment.

5 Troubleshooting

Issues	Solutions
No response from equipment	Please check that the plug is normal
Network can not be configured	Check that the router is working properly; WiFi the password correctly when configuring the network; restart the router and cat litter; reconfigure the network
Configured successfully but not remotely controlled	Check that the router is connected to the external network properly WiFi that the password input is incorrect; reconfigure the network
Cat litter basin not automatically cleaned	Enter APP to see if it is in automatic mode; check that the storage bin is full; restart the device
Cat litter allowance not updated	Wait 30 minutes to update automatically; or perform a clean-up task manually; the device will update immediately; restart the device
Cat litter box does not automatically return	You can click the "reset" button of the mobile app, or manually press the button on the front of the device to perform a cleanup. You can also unplug the power supply and wait for 10 seconds to plug it in. This may cause the cat litter to fall to the ground
Frequent pauses during cat litter bowl rotation	Please check if there is any debris on the shell of the equipment. Do not touch the equipment while running
Equipment notification of insufficient litter	Add litter and restart the device
Equipment notification storage bin full	Clean up store drawer
Equipment notification abnormal	Please see if there is a foreign body stuck in the equipment, clean up and wait for the equipment to recover automatically. Or manually perform a cleanup
Abnormal operation of equipment	Check for frequent switching between cleanup and clearance; re-power or perform a clean-up task

Thank u for u support. If you encounter any problems during use, please contact us. We are at your service and offer a 1 year warranty.